

WSM

WORKSHOP MANUAL

**ZG124E, ZG123S,
ZG127E, ZG127S**

Kubota

TO THE READER

This Workshop Manual tells the servicing personnel about the mechanism, servicing and maintenance of the ZG124E, ZG123S, ZG127E and ZG127S. It contains 4 parts: "**Information**", "**General**", "**Mechanism**" and "**Servicing**".

■ Information

This section primarily contains information below.

- Safety First
- Safety Decal
- Specification
- Dimension

■ General

This section primarily contains information below.

- Engine Identification
- Model Identification
- General Precautions
- Maintenance Check List
- Check and Maintenance
- Special Tools

■ Mechanism

This section contains information on the structure and the function of the unit. Before you continue with the subsequent sections, make sure that you read this section.

Refer to the latest version of Workshop Manual (Code No. 9Y021-18200) for tractor mechanism that this workshop manual does not include.

■ Servicing

This section primarily contains information below.

- Troubleshooting
- Servicing Specifications
- Tightening Torques
- Checking, Disassembling and Servicing

All illustrations, photographs and specifications contained in this manual are of the newest information available at the time of publication.

KUBOTA reserves the right to change all information at any time without notice.

Since this manual includes many models, information or illustrations and photographs can show more than one model.

© KUBOTA Corporation 2013

September, 2013

I INFORMATION

INFORMATION

CONTENTS

1. SAFETY FIRST	I-1
2. SAFETY DECALS	I-4
3. SPECIFICATIONS	I-8
4. DIMENSIONS	I-10

1. SAFETY FIRST

SAFETY FIRST

- This symbol, the industry's "Safety Alert Symbol", is used throughout this manual and on labels on the machine itself to warn of the possibility of personal injury. Read these instructions carefully.
- It is essential that you read the instructions and safety regulations before you try to repair or use this unit.

DANGER

- Indicates an imminently hazardous situation which, if not avoided, will result in death or serious injury.

WARNING

- Indicates a potentially hazardous situation which, if not avoided, could result in death or serious injury.

CAUTION

- Indicates a potentially hazardous situation which, if not avoided, may result in minor or moderate injury.

■ IMPORTANT

- Indicates that equipment or property damage could result if instructions are not followed.

■ NOTE

- Gives helpful information.

WSM000001INI0001US0

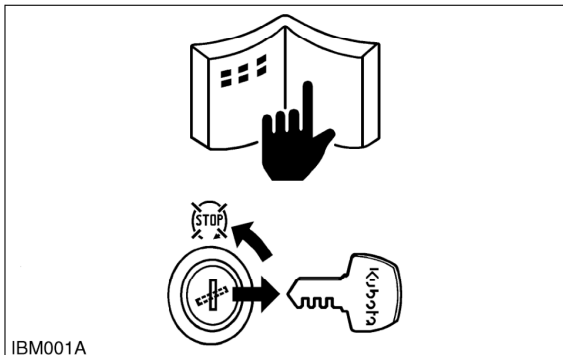

IBM001A

BEFORE YOU START SERVICE

- Read all instructions and safety instructions in this manual and on your machine safety decals.
- Clean the work area and machine.
- Park the machine on a stable and level ground, and set the parking brake.
- Lower the implement to the ground.
- Stop the engine, then remove the key.
- Disconnect the battery negative cable.
- Hang a "**DO NOT OPERATE**" tag in the operator station.

WSM000001INI0010US0

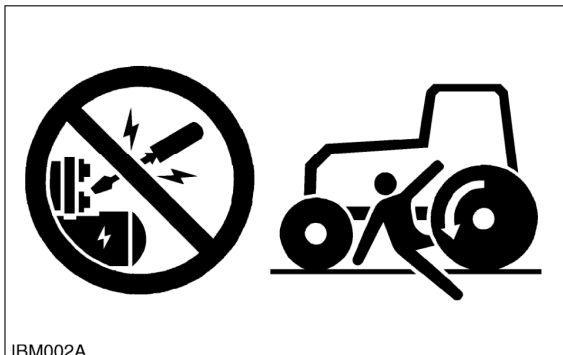

IBM002A

START SAFELY

- Do not do the procedures below when you start the engine.
 - short across starter terminals
 - bypass the safety start switch
- Do not alter or remove any part of machine safety system.
- Before you start the engine, make sure that all shift levers are in neutral positions or in disengaged positions.
- Do not start the engine when you stay on the ground. Start the engine only from operator's seat.

WSM000001INI0015US0

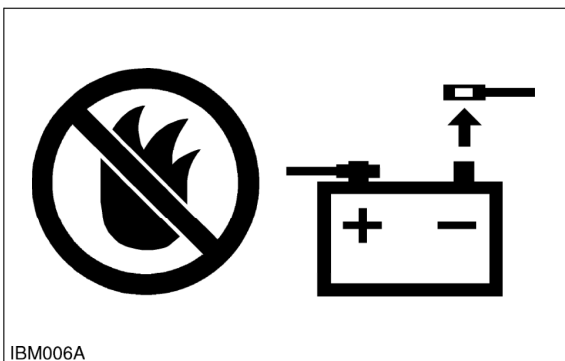
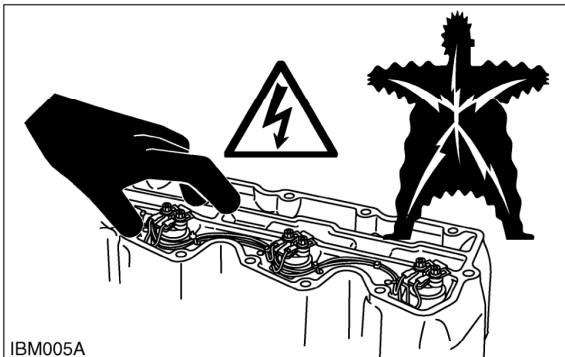
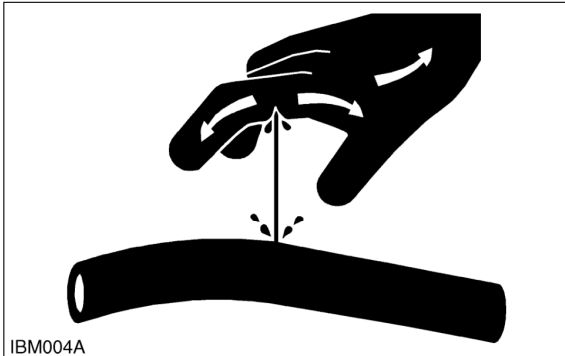
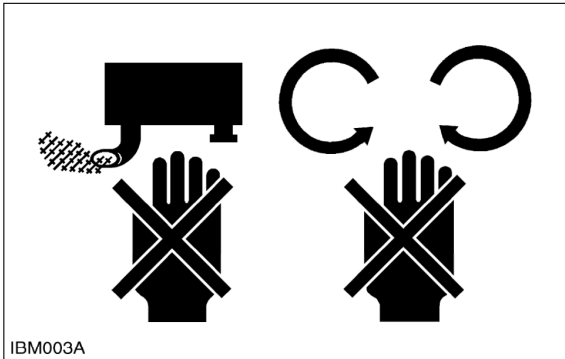

OPERATE SAFELY

- Do not use the machine after you consume alcohol or medication or when you are tired.
- Put on applicable clothing and safety equipment.
- Use applicable tools only. Do not use alternative tools or parts.
- When 2 or more persons do servicing, make sure that you do it safely.
- Do not operate below the machine that only a jack holds. Always use a safety stand to hold the machine.
- Do not touch the hot parts or parts that turn when the engine operates.
- Do not remove the radiator cap when the engine operates, or immediately after it stops. If not, hot water can spout out from the radiator. Only remove the radiator cap when it is at a sufficiently low temperature to touch with bare hands. Slowly loosen the cap to release the pressure before you remove it fully.
- Released fluid (fuel or hydraulic oil) under pressure can cause damage to the skin and cause serious injury. Release the pressure before you disconnect hydraulic or fuel lines. Tighten all connections before you apply the pressure.
- Do not open a fuel system under high pressure. The fluid under high pressure that stays in fuel lines can cause serious injury. Do not disconnect or repair the fuel lines, sensors, or any other components between the fuel pump and injectors on engines with a common rail fuel system under high pressure.
- Put on an applicable ear protective device (earmuffs or earplugs) to prevent injury against loud noises.
- Be careful about electric shock. The engine generates a high voltage of more than DC100 V in the ECU and is applied to the injector.

WSM000001INI0012US0

PREVENT A FIRE

- Fuel is very flammable and explosive under some conditions. Do not smoke or let flames or sparks in your work area.
- To prevent sparks from an accidental short circuit, always disconnect the battery negative cable first and connect it last.
- The battery gas can cause an explosion. Keep the sparks and open flame away from the top of battery, especially when you charge the battery.
- Make sure that you do not spill fuel on the engine.

WSM000001INI0005US0

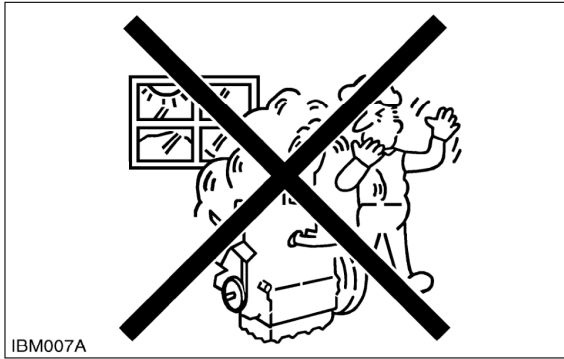

KEEP A GOOD AIRFLOW IN THE WORK AREA

- If the engine is in operation, make sure that the area has good airflow. Do not operate the engine in a closed area. The exhaust gas contains poisonous carbon monoxide.

WSM000001INI0006US0



DISCARD FLUIDS CORRECTLY

- Do not discard fluids on the ground, down the drain, into a stream, pond, or lake. Obey related environmental protection regulations when you discard oil, fuel, coolant, electrolyte and other dangerous waste.

WSM000001INI0007US0

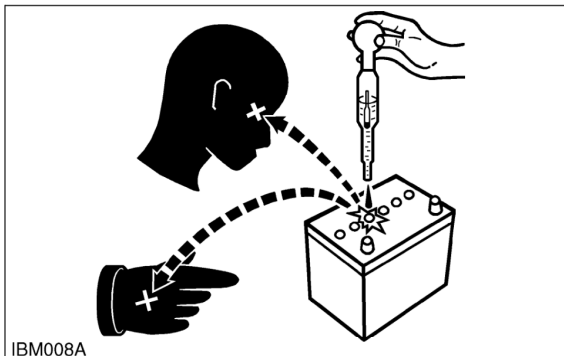

PREVENT ACID BURNS

- Keep electrolyte away from your eyes, hands and clothing. Sulfuric acid in battery electrolyte is poisonous and it can burn your skin and clothing and cause blindness. If you spill electrolyte on yourself, clean yourself with water, and get medical aid immediately.

WSM000001INI0008US0



PREPARE FOR EMERGENCIES

- Keep a first aid kit and fire extinguisher ready at all times.
- Keep the emergency contact telephone numbers near your telephone at all times.

WSM000001INI0009US0

2. SAFETY DECALS

The following safety decals are installed on the machine. If a decal becomes damaged, illegible or is not on the machine, replace it. The decal part number is listed in the parts list.

WSM000001INI0013US0

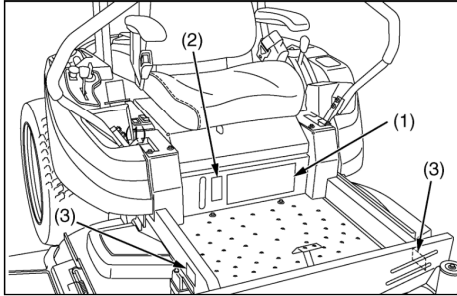

(1) Part No. K3011-6542-1

<p>▲WARNING</p> <p>TO AVOID SERIOUS INJURY OR DEATH</p> <ol style="list-style-type: none"> 1. Do not remove Roll-Over Protective Structures (ROPS) for any application. 2. Do not modify or repair a ROPS because welding, grinding, drilling or cutting any portion may weaken the structure. 3. Fasten SEAT BELT before operating. 	<p>▲WARNING</p> <p>TO AVOID SERIOUS INJURY OR DEATH</p> <ol style="list-style-type: none"> 1. Mow across slopes - Not up and down. 2. Use extreme caution when operating on slopes. 3. Loss of traction may occur when operating on slopes. 4. Drive slowly on slopes. 5. Do not operate on wet slopes. 6. Avoid sudden starts. 7. Execute turns slowly. 	<p>▲CAUTION</p> <p>TO AVOID PERSONAL INJURY</p> <ol style="list-style-type: none"> 1. Read and understand the operator's manual before operation. 2. Do not operate this machine unless you are trained. 3. Before allowing other people to use the machine, have them read the operator's manual. 4. Check the tightness of all nuts and bolts regularly. 5. Before starting the engine, make certain that everyone is at a safe distance from the machine, PTO is disengaged and motion control levers are in neutral lock. 6. Remove objects that could be thrown by the blade. 7. Do not operate the machine when children and/or others are around. 8. Do not carry children or others on the machine at any time. 9. Before dismounting, disengage PTO clutch, lower the implement, place motion control levers in neutral lock position, set the parking brake, stop the engine and remove the key. 10. Keep safety devices (guards, shields and switches) in place, and working. 11. To reduce the fire hazard, keep the exhaust clear of dry grass, dry leaves or other combustible materials. 12. This machine is not for street or highway use. 13. Securely support the machine and implement before working underneath.
<p>▲WARNING</p> <p>TO AVOID SERIOUS INJURY OR DEATH</p> <ol style="list-style-type: none"> 1. Park the machine on level ground. 2. If necessary to park on an incline, <ol style="list-style-type: none"> ⓐ Stop the machine. ⓑ Apply the parking brake. ⓒ Stop the engine. If you stop the engine on an incline without applying the parking brake, the machine could move and run away. 3. If the engine stops suddenly during operation, apply the parking brake immediately to prevent machine runaway. 		

1BDABDYAP058A

(2) Part No. K3014-6569-1



1BDABDYAP076A

(3) Part No. K3014-6545-1



1BDABDYAP077A

9Y1210968ICI001US

9Y1210968INI0001US0

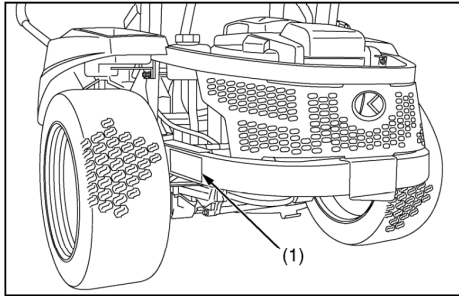

(1) Part No. K3011-6541-1

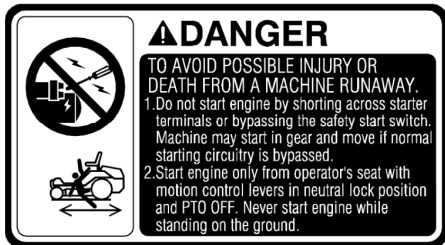

1BDABDYAP059A

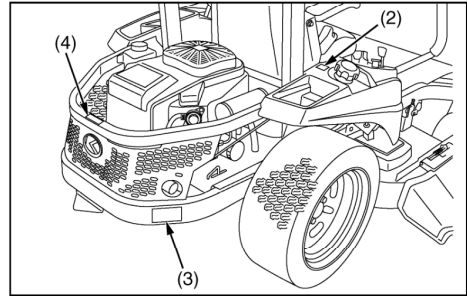

(2) Part No. K3011-6584-1



1BDABDYAP053A

(3) Part No. K3011-6543-1



1BDABDYAP060A

(4) Part No. K3011-6548-2

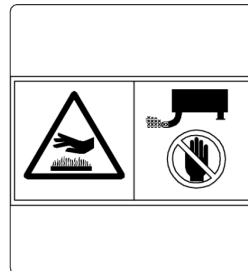

1BDABDYAP061A

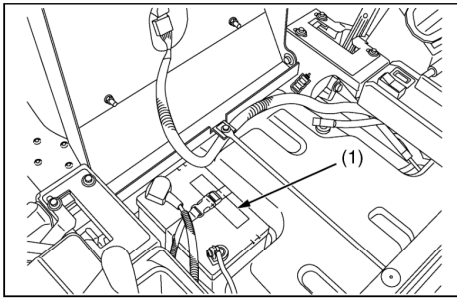

(1) Part No. K3011-6118-1

 FLAMMABLES	 SHIELD EYES	 KEEP OUT OF THE REACH OF CHILDREN	 CAUTION OF SULFURIC ACID	 READ INSTRUCTION MANUAL CAREFULLY	 EXPLOSIVE	<h2 style="margin: 0;">SMF U1-300</h2> <table border="1" style="width: 100%; border-collapse: collapse;"> <tr> <td style="padding: 2px;">NOMINAL VOLTAGE</td> <td style="text-align: right; padding: 2px;">12V</td> </tr> <tr> <td style="padding: 2px;">COLD CRANKING AMPS</td> <td style="text-align: right; padding: 2px;">300</td> </tr> <tr> <td style="padding: 2px;">CRANKING AMPS</td> <td style="text-align: right; padding: 2px;">410</td> </tr> <tr> <td style="padding: 2px;">RESERVE CAPACITY(MINUTES)</td> <td style="text-align: right; padding: 2px;">45</td> </tr> </table>	NOMINAL VOLTAGE	12V	COLD CRANKING AMPS	300	CRANKING AMPS	410	RESERVE CAPACITY(MINUTES)	45
NOMINAL VOLTAGE	12V													
COLD CRANKING AMPS	300													
CRANKING AMPS	410													
RESERVE CAPACITY(MINUTES)	45													
<p>DANGER EXPLOSIVE GASES CIGARETTES, FLAMES OR SPARKS COULD CAUSE BATTERY TO EXPLODE. ALWAYS SHIELD EYES AND FACE FROM BATTERY. DO NOT CHARGE OR USE BOOSTER CABLES OR ADJUST POST CONNECTIONS WITHOUT PROPER INSTRUCTION AND TRAINING. CALIFORNIA PROPOSITION 65 WARNING : Batteries, battery posts, terminals and related accessories contain lead and lead compounds, and other chemicals known to the State of California to cause cancer and birth defects or other reproductive harm. WASH HANDS AFTER HANDLING.</p> <p>POISON CAUSES SEVERE BURNS CONTAINS SULFURIC ACID. AVOID CONTACT WITH SKIN, EYES OR CLOTHING. IN EVENT OF ACCIDENT FLUSH WITH WATER AND CALL A PHYSICIAN IMMEDIATELY. KEEP OUT OF REACH OF CHILDREN</p>														
MADE IN KOREA YEAR (0) (1) (2) (3) (4) (5) (6) (7) (8) (9) MONTH (1) (2) (3) (4) (5) (6) (7) (8) (9) (10) (11) (12)														

1BDABDYAP062A

DANGER -EXPLOSIVE GASES-

- CIGARETTES, FLAMES OR SPARKS COULD CAUSE BATTERY TO EXPLODE.
- ALWAYS SHIELD EYES AND FACE FROM BATTERY.
- DO NOT CHARGE OR USE BOOSTER CABLES OR ADJUST POST CONNECTIONS WITHOUT PROPER INSTRUCTION AND TRAINING.

POISON -CAUSE SEVERE BURNS-

- CONTAINS SULFURIC ACID, AVOID CONTACT WITH SKIN, EYES OR CLOTHING.
- IN EVENT OF ACCIDENT FLUSH WITH WATER CALLA PHYSICIAN IMMEDIATELY.

WASH HANDS AFTER HANDLING
 KEEP OUT REACH OF CHILDREN

9Y1210968ICI003US

9Y1210968INI0003US0

[RCK48P, RCK54P]

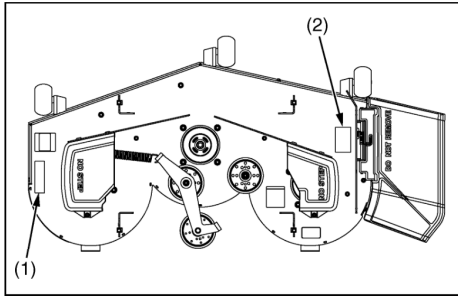

(1) Part No. K5617-7311-1



1BDABBSAP0030

(2) Part No. K5617-7312-1



1BDABBSAP0020

9Y1210968ICI004US

9Y1210968INI0004US0

CARE OF DANGER, WARNING, AND CAUTION LABELS

1. Keep danger, warning and caution labels clean and free from obstructing material.
2. Clean danger, warning and caution labels with soap and water, and dry with a soft cloth.
3. Replace damaged or missing danger, warning and caution labels with new labels from your local KUBOTA Dealer.
4. If a component with danger, warning and caution label(s) affixed is replaced with new part, make sure new label(s) is (are) attached in the same location(s) as the replaced component.
5. Mount new danger, warning and caution labels by applying on a clean dry surface and pressing any bubbles to outside edge.

9Y1210968INI0005US0

3. SPECIFICATIONS

Model		ZG124E	ZG123S	ZG127E	ZG127S
Engine	Model	GH731V	GH732V	GH733V	GH734V
	Max. engine power (Gross)	17.9 kw (24 HP) *1*2	17.2 kw (23 HP) *1*3	20.1 kw (27 HP) *1*2	20.1 kw (27 HP) *1*3
	Type	Air-cooled gasoline engine			
	Number of cylinders	2 (V-Twin)			
	Bore and stroke	79 × 73 mm (3.11 × 2.87 in.)	83 × 67 mm (3.27 × 2.64 in.)	79 × 73 mm (3.11 × 2.87 in.)	83 × 67 mm (3.27 × 2.64 in.)
	Total displacement	724 cm ³ (44 cu. in.)	725 cm ³ (44 cu. in.)	724 cm ³ (44 cu. in.)	725 cm ³ (44 cu. in.)
	Rated revolution	3600 rpm			
	Fuel	Unleaded gasoline			
	Starter	Electric			
	Lubrication	Full pressure lubrication			
	Cooling	Air cooled			
	Battery	U1 (12 V, RC: 45 min, CCA: 300, CA: 410)			
Capacities	Fuel tank	16 L (4.2 U.S.gals, 0.92 Imp.gals)			
	Engine crankcase (with filter)	1.8 L (1.9 U.S.qts, 1.6 Imp.qts)			
	Transmission case including Rear axle gear case	4.8 L (5.1 U.S.qts, 4.2 Imp.qts) *4			
Dimensions	Overall length	1940 mm (76.4 in.)			
	Overall width w/o mower deck	1207 mm (47.5 in.)			
	Overall height	1652 mm (65.0 in.)			
	Wheelbase	1155 mm (45.5 in.)			
	Min. ground clearance	123 mm (4.84 in.) W/48"		123 mm (4.84 in.) W/54"	
	Tread	Front	796 mm (31.3 in.)		Rear
Weight (W/MOWER DECK)		330 kg (728 lbs) with 48"	340 kg (750 lbs) with 48"	340 kg (750 lbs) with 54"	350 kg (772 lbs) with 54"
Traveling system	Tread	Front	11 × 4 - 5 (4PR) Smooth		
		Rear	22 × 10 - 14 (4PR) Turf		
	Traveling speeds	Forward	0 to 12.9 km/h (0 to 8.0 mph)		
		Reverse	(0 to 6.4 km/h (0 to 4.0 mph)		
	Steering	2 - Hand levers			
	Transmission	2 - HST w / Gear			
	Parking brake	Hand lever applied, released			
Min. turning radius	0 mm (0 in.)				
PTO	Drive system	Belt			
	Clutch type	Electric			

(Specifications and design subject to change without notice)

NOTE

- *1: Manufacturer's estimate

*2: The gross power rating for individual gas engine models is labeled in accordance with SAE (Society of Automotive Engineers) code J1940 (Small Engine Power & Torque Rating Procedure), and rating performance has been obtained and corrected in accordance with SAE J1995 (Revision 2002-05). Torque values are derived at 3060 RPM; horsepower values are derived at 3600 RPM. Actual gross engine power will be lower and is affected by, among other things, ambient operating conditions and engine-to-engine variability. Given both the wide array of products on which engines are placed and the variety of environmental issues applicable to operating the equipment, the gas engine will not develop the rated gross power when used in a given piece of power equipment (actual "onsite" or net power). This difference is due to a variety of factors including, but not limited to, accessories (air cleaner, exhaust, charging, cooling, carburetor, fuel pump, etc.), application limitations, ambient operating conditions (temperature, humidity, altitude), and engine-to-engine variability. Due to manufacturing and capacity limitations, Briggs & Stratton may substitute an engine of higher rated power for this Series engine.

*3: Horsepower ratings exceed Society of Automotive Engineers Small Engine Test Code J1940. Actual engine horsepower is lower and affected by, but not limited to, accessories (air cleaner, exhaust, charging, cooling, fuel pump, etc.), application, engine speed and ambient operating conditions (temperature, humidity, and altitude).

Kohler reserves the right to change product specifications, design, and standard equipment without notice and without incurring obligation.

*4: Oil amount when the oil level is at the upper level.

Model		RCK48P-124Z	RCK54P-127Z
PRO Commercial Deck (Fabricated deck)	Suitable machine	ZG124E, ZG123S	ZG127E, ZG127S
	Mounting method	Parallel linkage	
	Adjustment of cutting height	Dial gauge	
	Cutting width	1225 mm (48 in.)	1375 mm (54 in.)
	Cutting height	38 to 114 mm (1.5 to 4.5 in.)	
	Weight (Approx.)	60 kg (132 lbs)	68 kg (150 lbs)
	Blade spindle speed	69.1 r/s (4140 rpm) *1	61.7 r/s (3700 rpm) *1
	Blade tip velocity	92.0 m/s (18100 rpm) *1	92.0 m/s (18100 rpm) *1
	Blade length	424 mm (16.7 in.)	475 mm (18.7 in.)
	Number of blades	3	
	Dimensions	Total length	880 mm (34.6 in.)
Total width		1552 mm (61.1 in.)	1710 mm (67.3 in.)
Total height		340 mm (13.3 in.)	

*1: Engine Max rpm

9Y1210968INI0006US0

4. DIMENSIONS

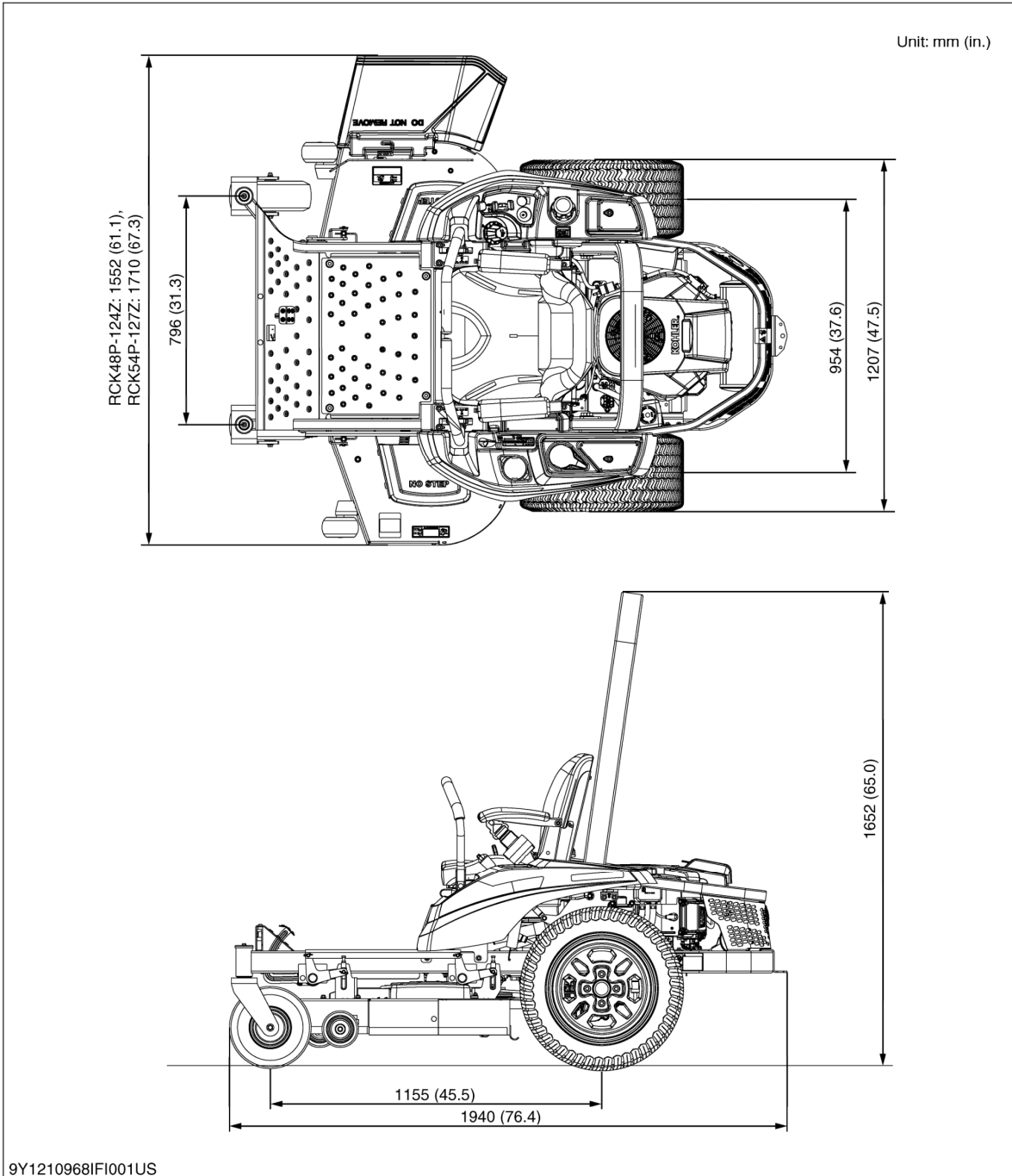

9Y1210968IFI001US

9Y1210968INI0007US0

G GENERAL